

# Inspire

BAHAMAS /  
RÉUNION

EAN : 3276007345612 / 3276007345582  
Ref : M52021-XY-3L(WH) / M52021-XY-3L(AB)

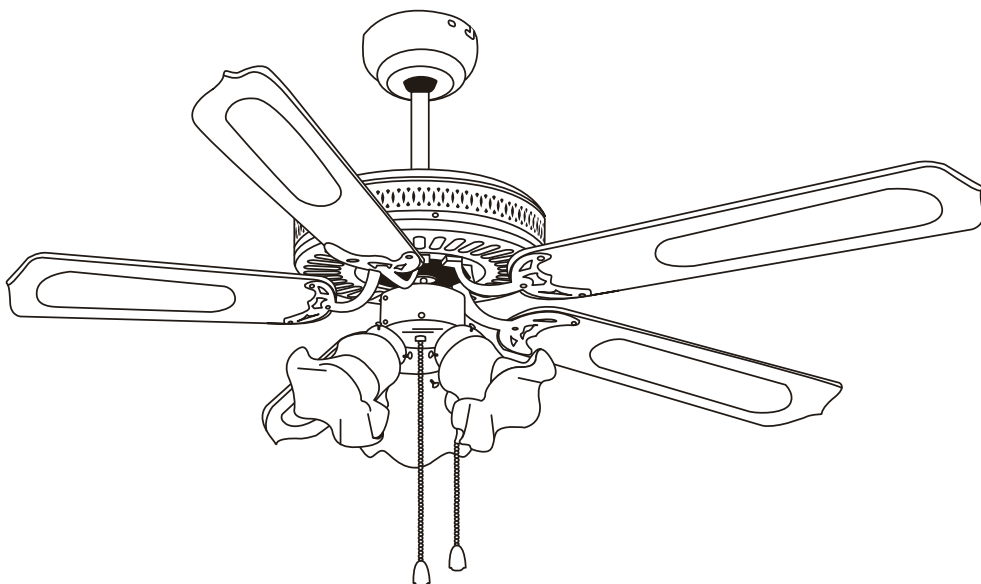

2/2



2025-01-V01

FR - Manuel d'Instructions

ES - Manual de Instrucciones

PT - Manual de Instruções

IT - Manuale di Istruzioni

EL - Εγχειρίδιο Οδηγιών

PL - Instrukcja Obsługi

UA - Інструкція з Експлуатації

RO - Manual de Instrucțiuni

BR - Manual de Instrução

NL - Handleiding

DE - Anleitung Handbuch

EN - Instructions Manual

\*Année de garantie / años de garantía / Ano de garantía / Anno di garanzia / Έτος εγγύησης / Rok gwarancji / Гарантія років / Anul de garanție / Anos de garantía / Garantiejaar / Jahr der Garantie / Year of guarantee

\*\*réparable / reparabile / reparável / riparabile / διορθώσιμος / naprawiany / ремонтний / reparabil / reparaturfähig / reparável / herstelbaar / reparierbar / repairable



**FR** : assemblage / **ES** : ensamblaje / **PT** : montagem / **IT** : assemblaggio /  
**EL** : συναρμολόγηση / **PL** : montaż / **UA** : збірка / **RO** : asamblare /  
**BR** : montagem / **NL** : samenstelling / **DE** : Montage / **EN** : assembly





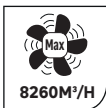
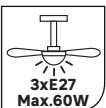
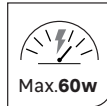
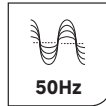

**FR** : Utilisation / **ES** : Uso / **PT** : Utilização / **IT** : Utilizzo  
**EL** : Χρήση / **PL** : Użycie / **UA** : Використання / **RO** : Utilizare /  
**BR** : Utilização / **NL** : Gebruik / **DE** : Verwendung / **EN** : Use

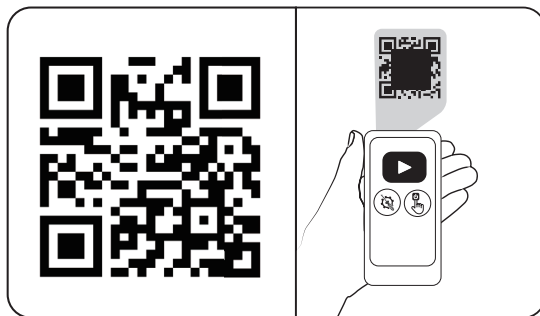
**FR** : CARACTÉRISTIQUES TECHNIQUES / **ES** : CARACTERÍSTICAS TÉCNICAS /  
**PT** : CARACTERÍSTICAS TÉCNICAS / **IT** : CARATTERISTICHE TECNICHE / **EL** : ΤΕΧΝΙΚΑ  
ΧΑΡΑΚΤΗΡΙΣΤΙΚΑ / **PL** : CECHY TECHNICZNE / **UA** : ТЕХНІЧНІ ХАРАКТЕРИСТИКИ /  
**RO** : CARACTERISTICI TEHNICE / **BR** : CARACTERÍSTICAS TÉCNICAS / **NL** : TECHNISCHE KENMERKEN  
/ **DE** : TECHNISCHE MERKMALE / **EN** : TECHNICAL SPECIFICATIONS



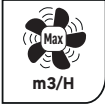

- FR** : Scanner ce code QR pour voir la vidéo de montage  
**ES** : Escanear este código QR para ver el video de montaje  
**PT** : Digitalize este código QR para ver o vídeo de montagem  
**IT** : Scannerizza questo codice QR per vedere il video di montaggio  
**EL** : Σαρώστε τον συγκεκριμένο κωδικό QR για να δείτε το βίντεο συναρμολόγησης  
**PL** : Zeskanuj ten kod QR, aby zobaczyć wideo montażowe  
**UA** : Відскануйте цей QR-код, щоб переглянути відео про монтаж  
**RO** : Scaņați acest cod QR pentru a viziona videoclipul de montaj  
**BR** : Escanear este código QR para ver o vídeo de montagem  
**NL** : Scan deze QR-code om de montagevideo te bekijken  
**DE** : Scannen Sie diesen QR-Code, um das Montagevideo anzusehen  
**EN** : Scan this QR code to view the assembly video

	<b>1</b>	<b>2</b>	<b>3</b>
	35,2	41,9	57,5
	89	156	196
	2730	6500	8260
	1,3	2,6	2,4
	35,4	45	52,2

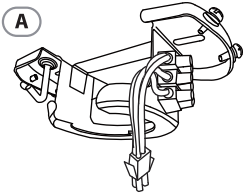

A



B1



E x15

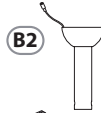

B2

H x2

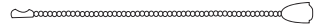

C x5

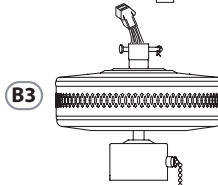
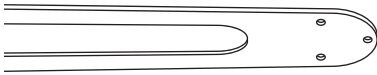

B3



I

D x5



G x3



F

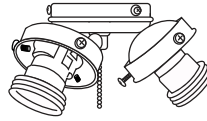

J x3



K x2



0 1 2 3 4 5 6 7 8 cm

+

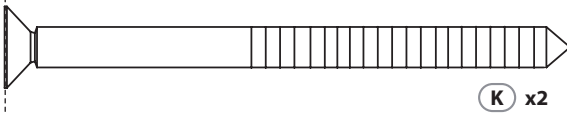

K x2

+



E x15

+



L x4

+



M x10

+

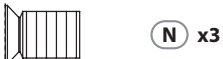

N x3

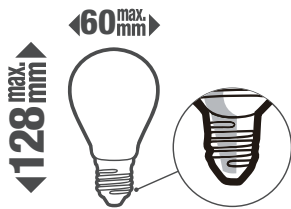
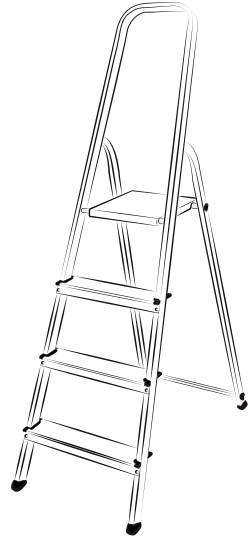
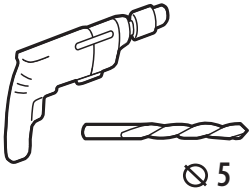

**E27x3 MAX 60W**

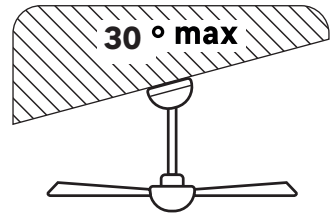
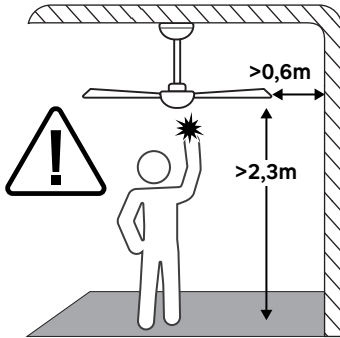
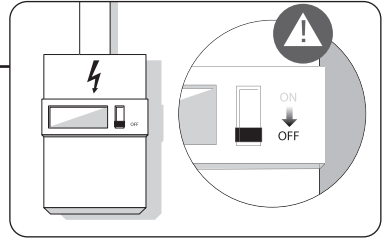

1

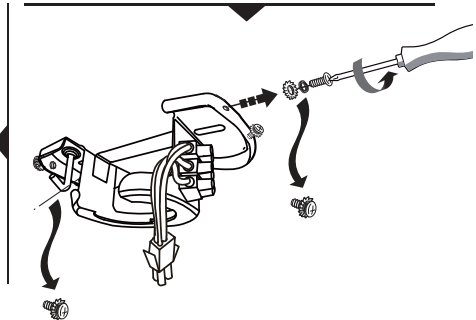
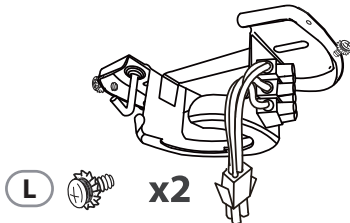
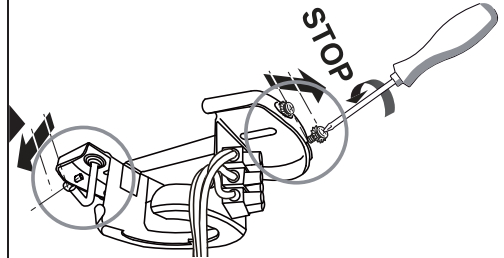
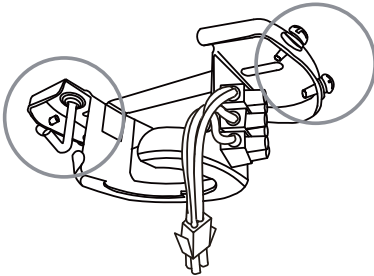

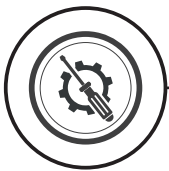

# 2

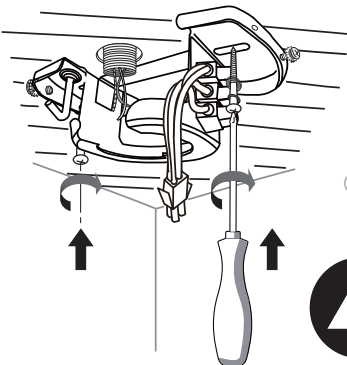

OR

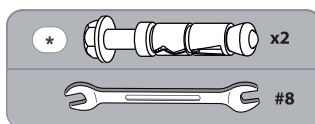
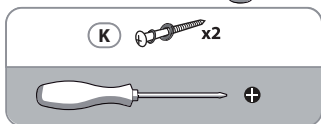
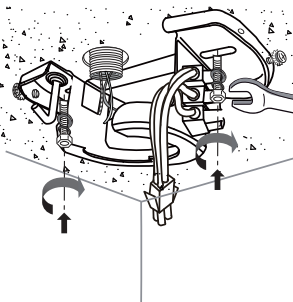

**FR** - fixé avec une résistance suffisante pour résister à 4 fois le poids du ventilateur de plafond / **ES** - fijado con una resistencia suficiente para soportar 4 veces el peso del ventilador de techo / **PT** - fixado com uma resistência suficiente para suportar 4 vezes o peso do ventilador de teto / **IT** - fissato con una resistenza sufficiente per resistere a 4 volte il peso del ventilatore a soffitto / **GR** - στερεωμένο με επαρκή αντοχή για να αντέξει 4 φορές το βάρος του ανεμιστήρα οροφής / **PL** - przytworowany z wystarczającą wytrzymałością, aby wytrzymać 4 razy ciężar wentylatora sufitowego / **UA** - закріплення з достатньою міцністю, щоб витримати 4-кратний вагу стельового вентилятора / **RO** - fixat cu o rezistență suficientă pentru a rezista la 4 ori greutatea ventilatorului de tavan / **BR** - fixado com uma resistência suficiente para suportar 4 vezes o peso do ventilador de teto / **NL** - bevestigd met voldoende sterkte om 4 keer het gewicht van de plafondventilator te weerstaan / **DE** - mit ausreichender Festigkeit befestigt, um 4-mal das Gewicht des Deckenventilators zu tragen / **EN** - fixed with sufficient strength to withstand 4 times the weight of the ceiling fan

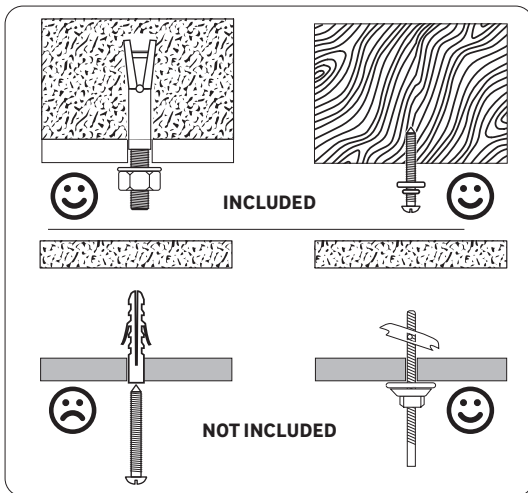
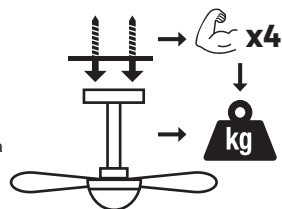

**FR** - Utiliser des vis et des chevilles adaptées à votre support. / **ES** - Utilice tacos y tornillos adecuados al soporte. / **PT** - Utilize buchas e parafusos adequados ao seu suporte. / **IT** - Utilizzare viti e tasselli adatti per il retro. / **GR** - Χρησιμοποιήστε βίδες και βύσματα που ταίριαζουν στην επιφάνεια στήριξης. / **PL** - Należy użyć śrub i kołków odpowiednich dla podłoża. / **UA** - Використовуйте гвинти та шканти, призначені для задньої поверхні. / **RO** - Utilizați șuruburi și dibluri adecvate pentru suportul dvs. / **BR** - Use parafusos e buchas adequados para seu suporte. / **NL** - Gebruik schroeven en pluggen die geschikt zijn voor uw ondergrond. / **DE** - Verwenden Sie für Ihre Unterlage geeignete Schrauben und Dübel. / **EN** - Use screws and dowels suited to your backing.



3

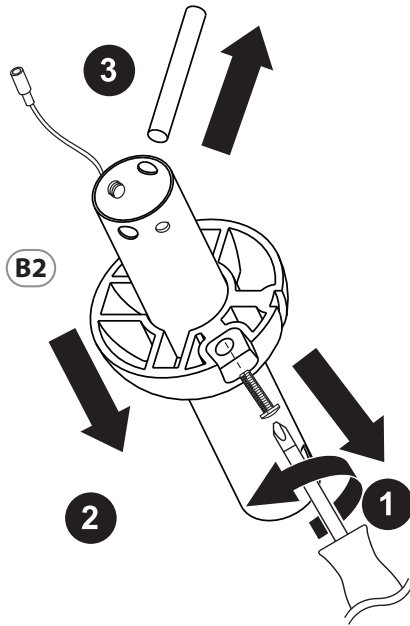

4

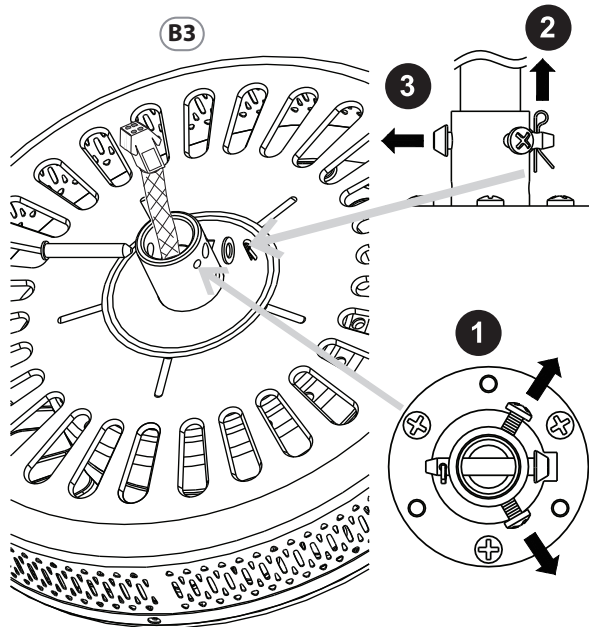

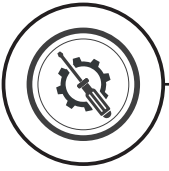

5

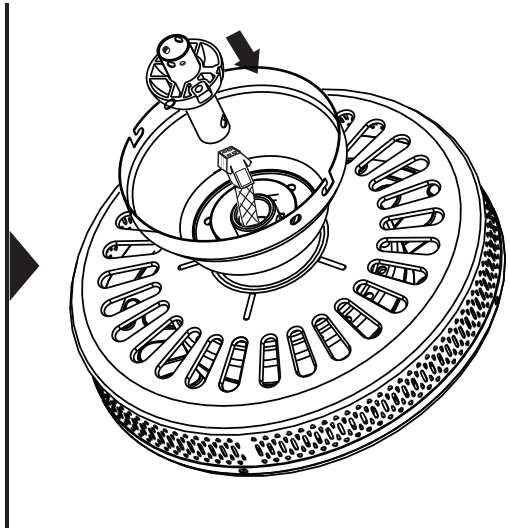
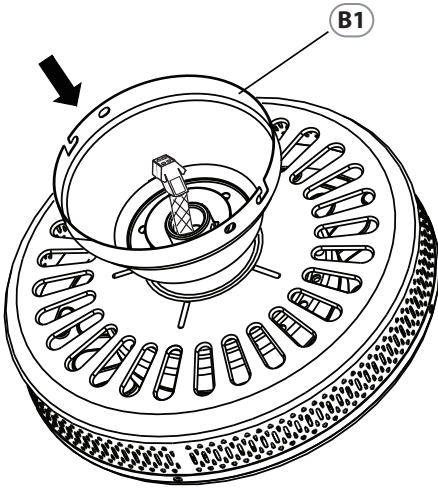

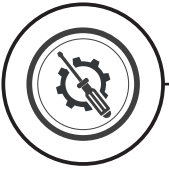

6

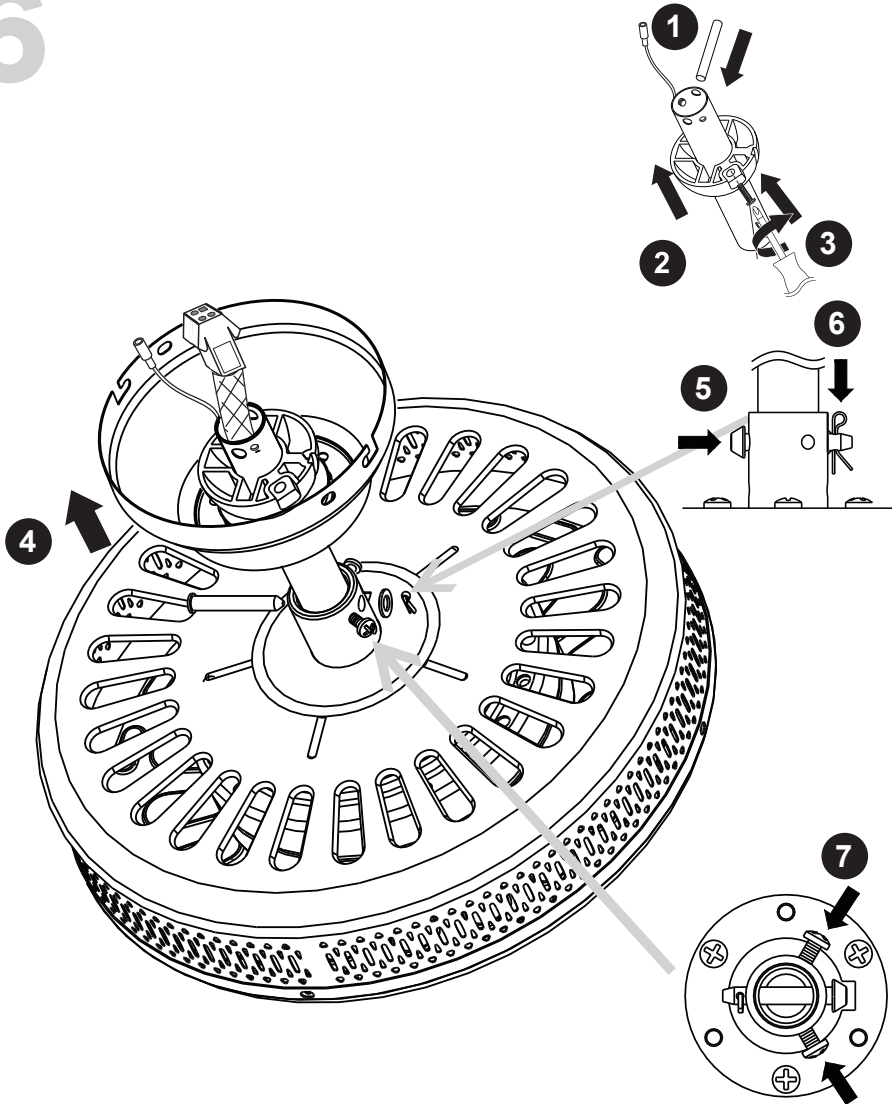



7

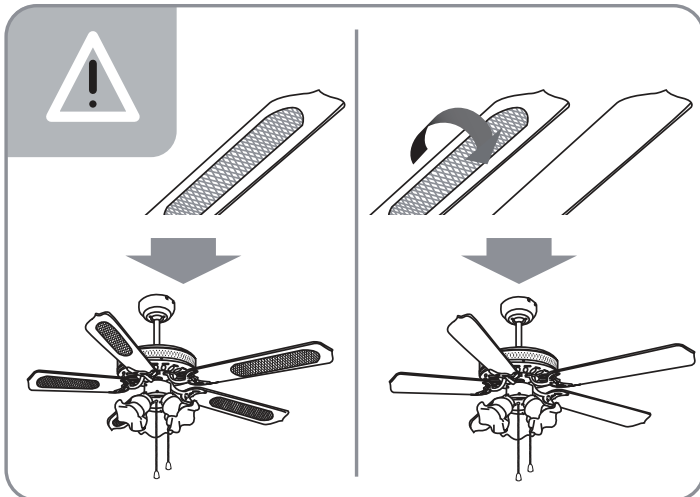
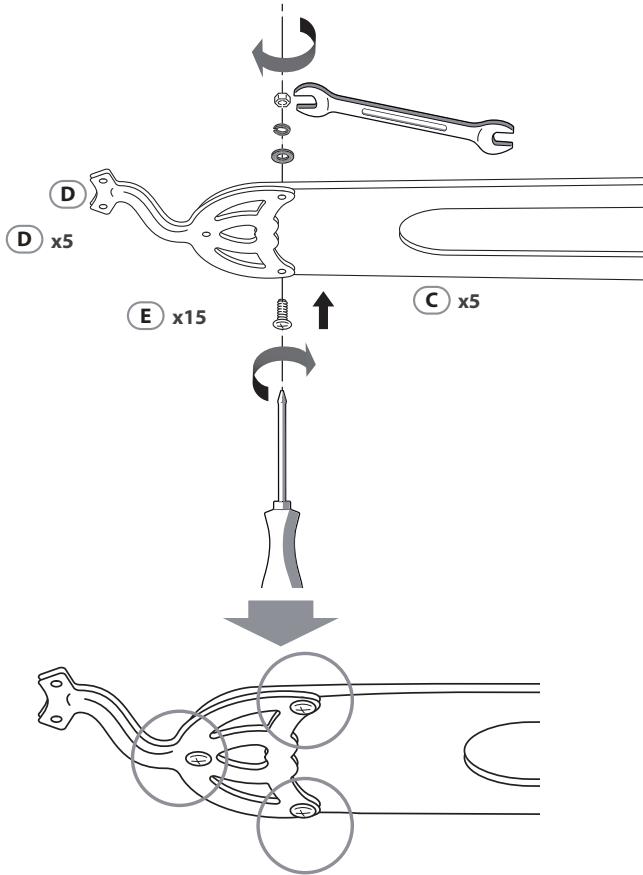



8

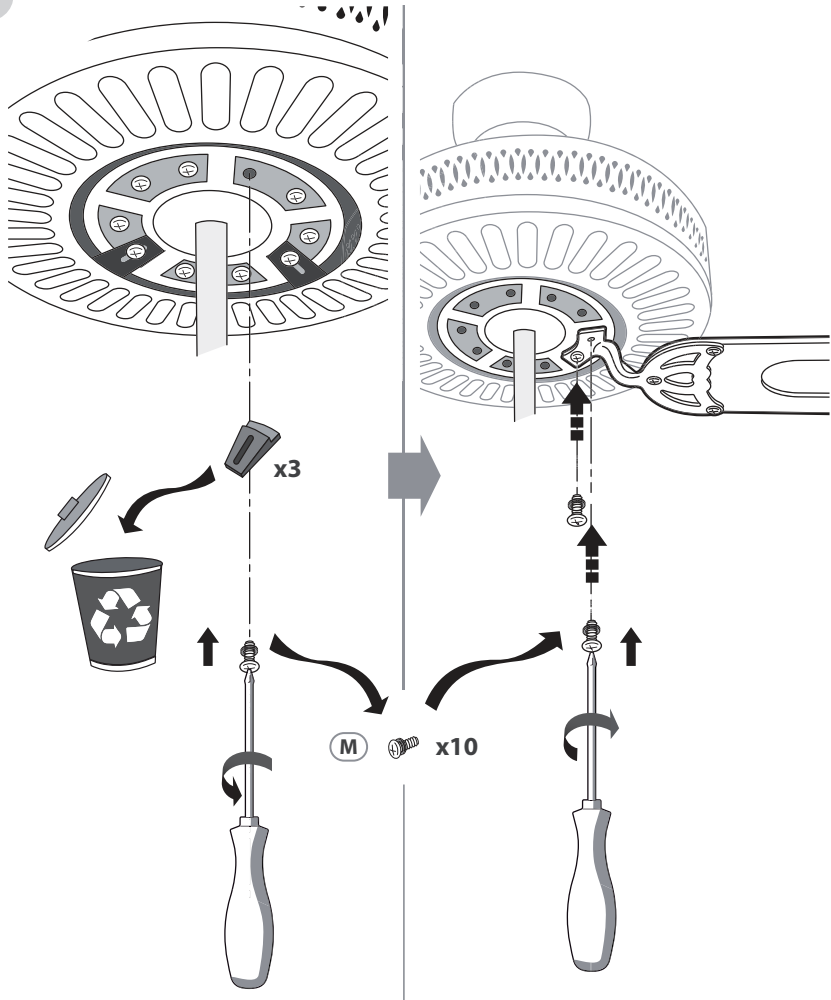



9

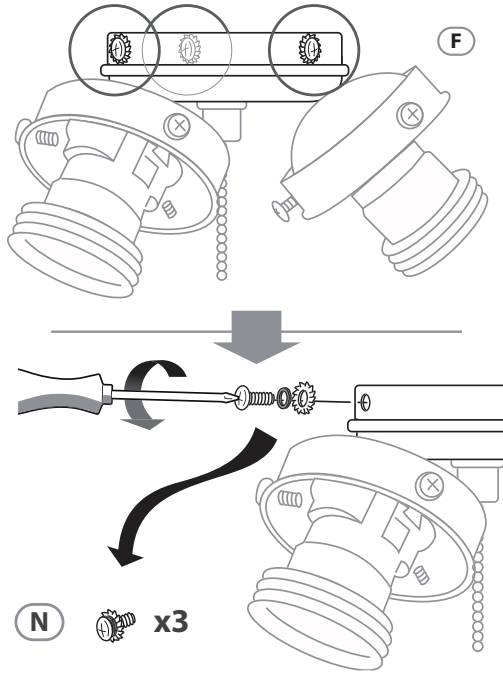

10

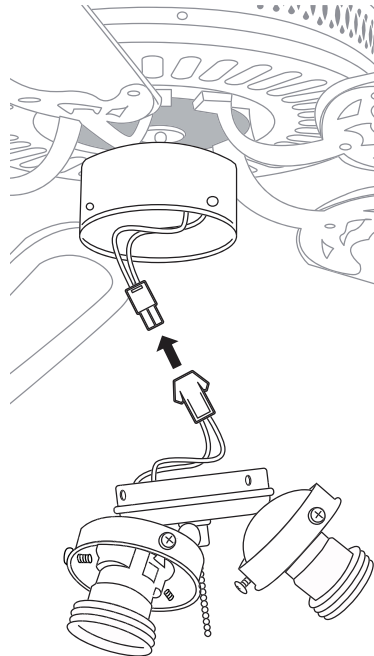
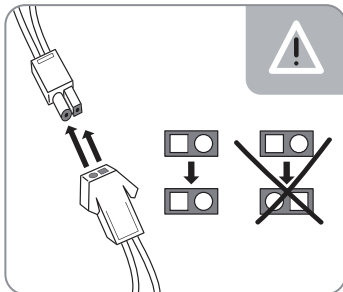

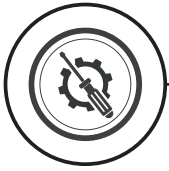

11

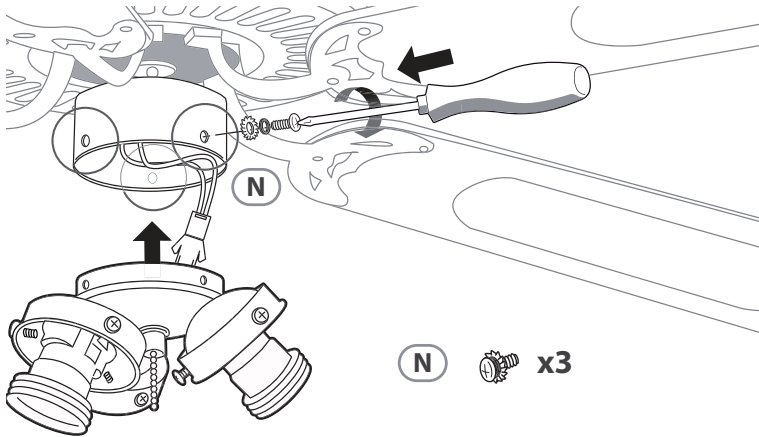

12

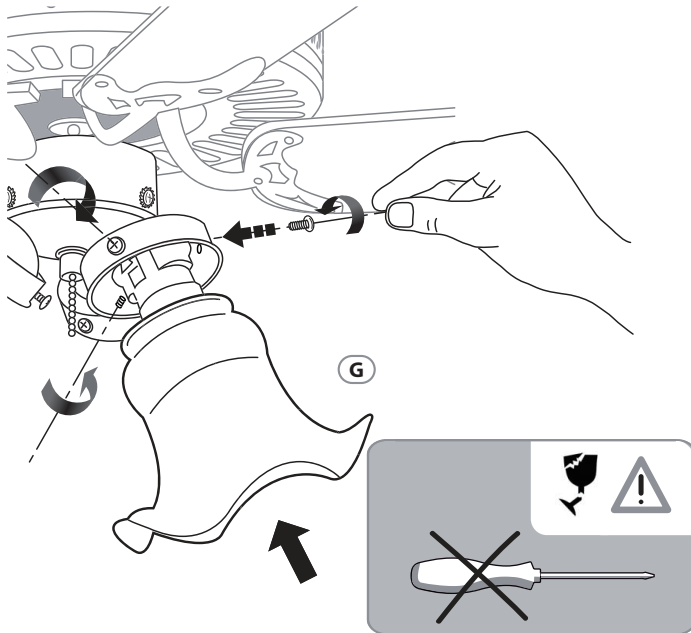



13

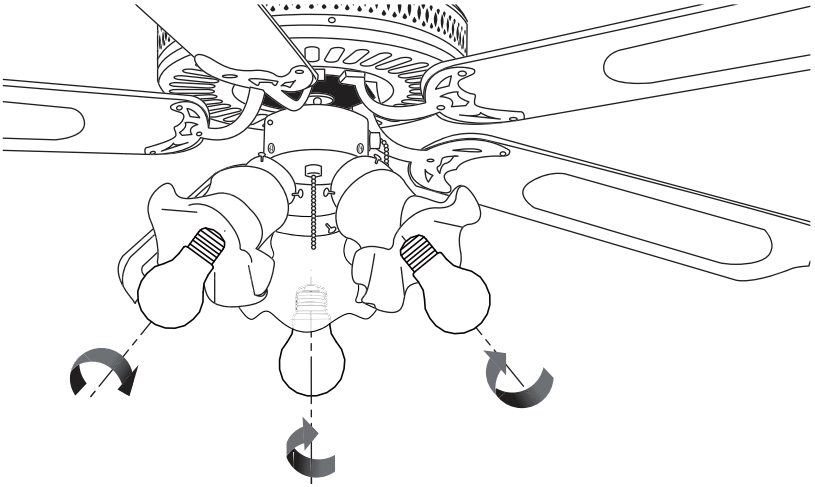

14

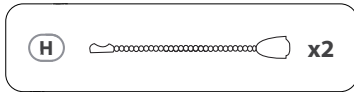
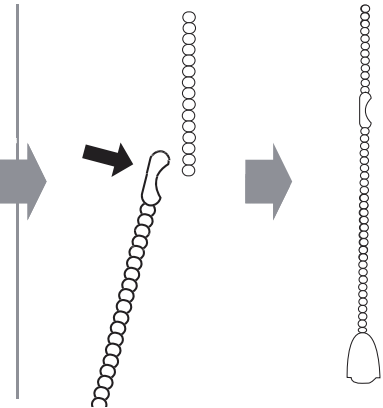
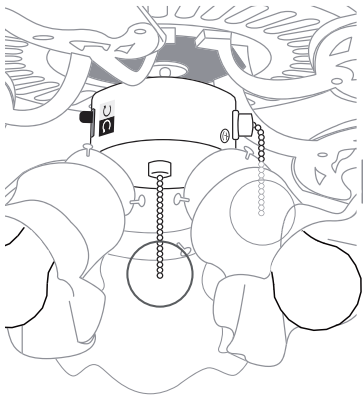



# 15

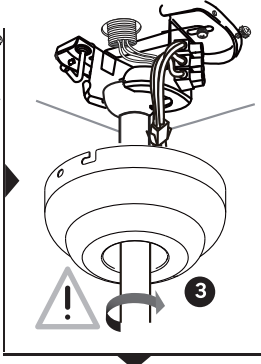
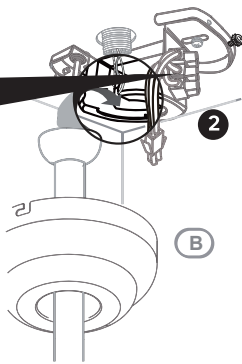
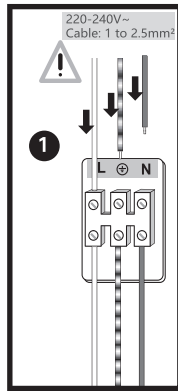

- L= Marron/Marrón/Castanho/Marrone/  
Кафе́/Brązowy/Коричневый/Қоңыр/  
Коричневий/Maró/Castanho/Brown
- N= Bleu/Azul/Azul/Blu/Mtłę/  
Niebieski/Синий/Көк/  
Синий/Albastru/Azul/Blue
- ⊕= Vert/Verde/Verde/Verde/  
Прáсныц/Zielony/Зеленый/  
Жасыл/Зелений/Verde/  
Verde/Green

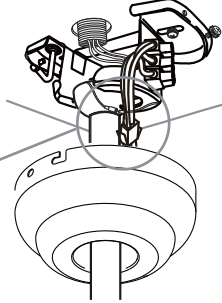
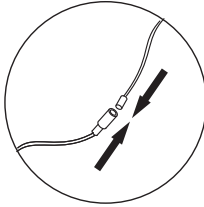

# 16

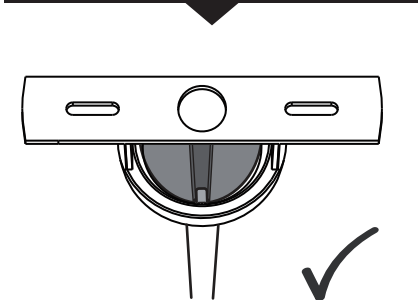
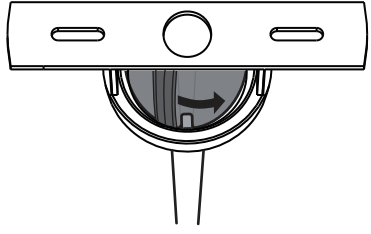
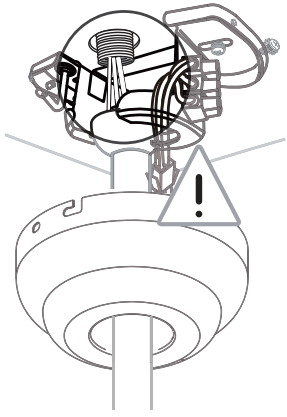

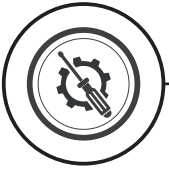

17

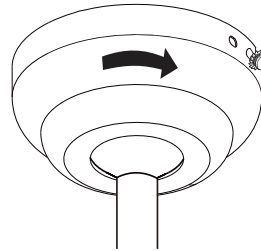
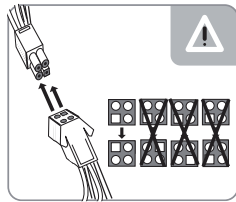
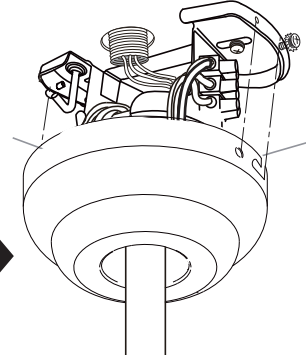
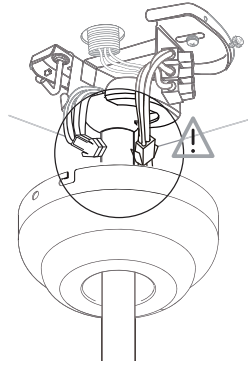

18

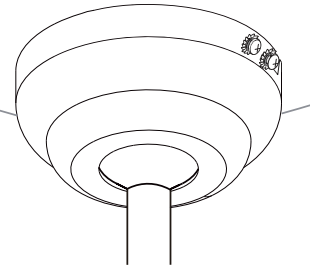
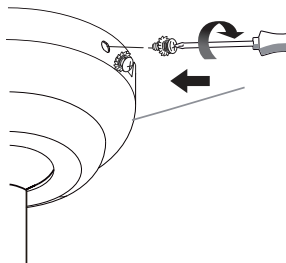
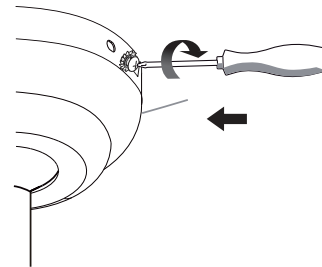
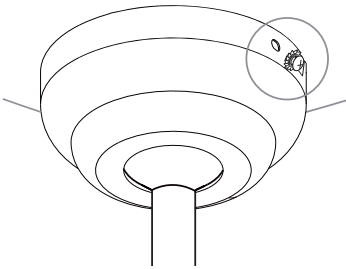

I  x2

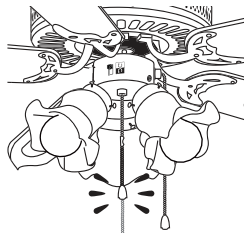

**ON/OFF**

Lumière seulement/Solo luz/Apenas luz/Solo luce/Mόνο φως/ Tyłko światło/ Тільки світло/Doar lumina/Alleen licht /Nur Licht/**Light only**

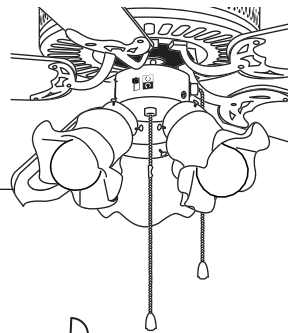
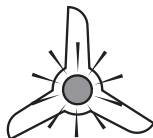
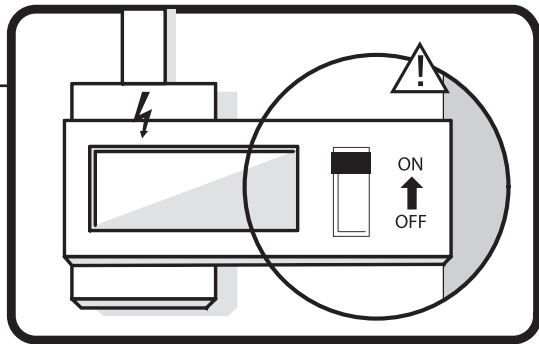

**1**

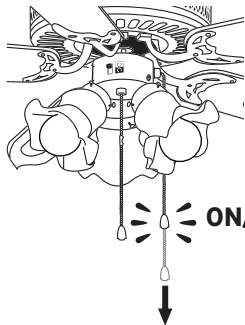

**ON/OFF**

**2**

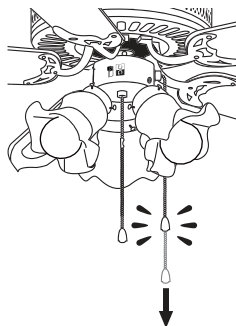

**1 - 2 - 3**



Vitesse/Velocidad/Velocidade/Velocità /Ταχύτητα/Prędkość/Швидкість/Vitezá /Snelheid/Geschwindigkeit/Speed

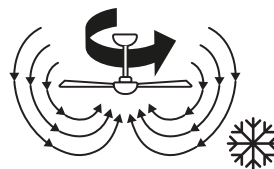
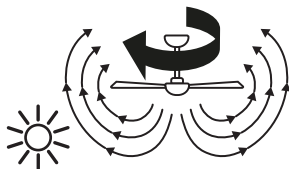
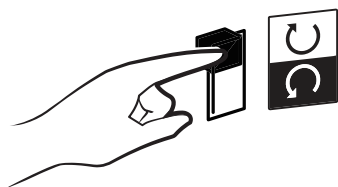

Été/Hiver- Verano/Invierno -  
Verão/Inverno - Estate/Inverno -  
Καλοκαίρι/Χειμώνας - Lato/Zima -  
Літо/Зима - Ará/larná - Zomer/Winter -  
Sommer/Winter - Summer/Winter

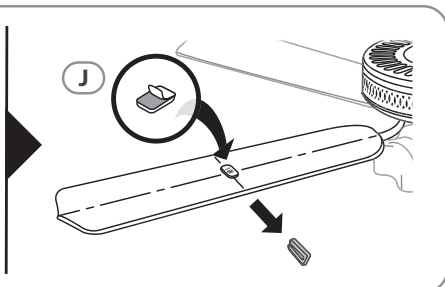
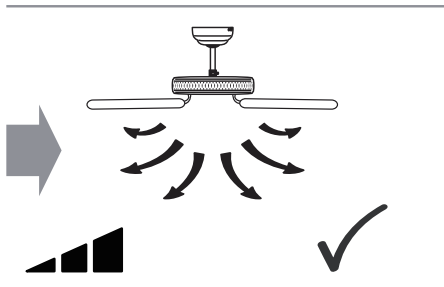
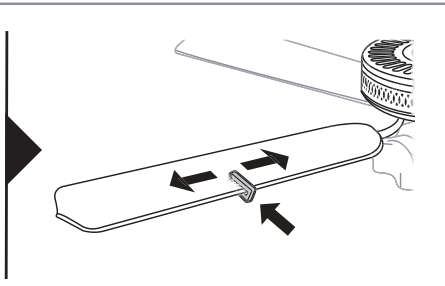
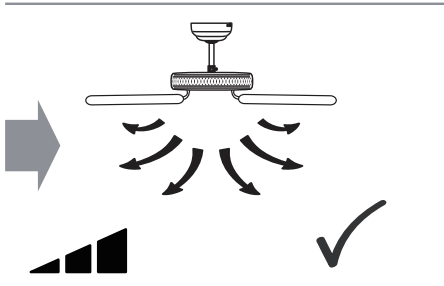
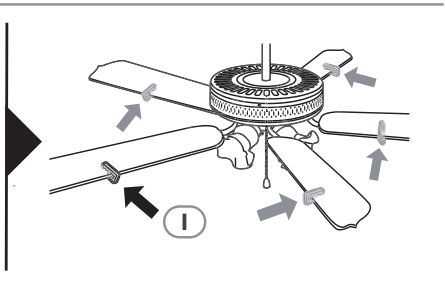
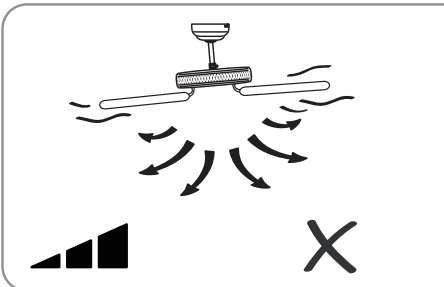
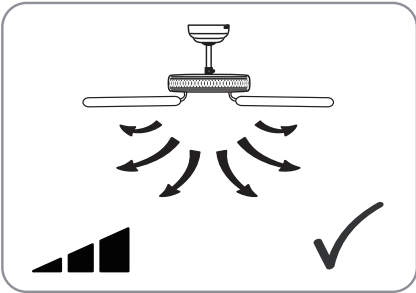

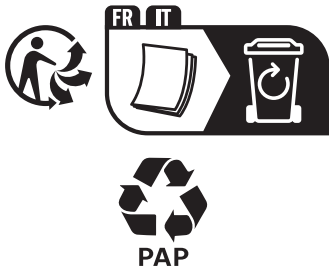

FR Traduction de la version originale du mode d'emploi / ES: Traducción de las Instrucciones originales / PT: Tradução das Instruções Originais / IT: Traduzione delle istruzioni originali / EL: Μετάφραση των πρωτότυπων οδηγιών / PL: Tłumaczenie instrukcji oryginalnej / UA: Переклад оригінальної інструкції / RO: Traducerea instrucțiunilor originale / BR: Tradução das Instruções Originais / DE: Übersetzung der Originalversion der Gebrauchsanweisung / Original Instructions.

Made in China  
Країна походження: Китай

**EU** ADEO Services - 135 Rue Sadi Carnot - CS00001 - 59790 RONCHIN - FRANCE

**UA** Виробник: ТОВ "Адео Сервісез С.А.", вул. Саді Карно, CS 00001, 59790 Роншен, Франція.  
Імпортер: ТОВ "Леруа Мерлен Україна", 04201 Україна, м. Київ, вул. Полярна 17А, +380 44 498 46 00. Імпортер приймає претензії від споживачів щодо товару, а також проводить його ремонт, технічне і гарантійне обслуговування

**ZA** Imported by Adeo South Africa (PTY) LTD T/A Leroy Merlin, Hosted in Leroy Merlin Fourways Store 35 Roos Street, Witkoppen Ext 97, Sandton, 2191 Johannesburg, Gauteng, South Africa.  
Tel: +27 10 493 8000 Email: contact@leroymerlin.co.za.

**BR** LEROY MERLIN COMPANHIA BRASILEIRA DE BRICOLAGEM CNPJ: 01.438.784/0001-05  
Rua Pascoal Pais, nº. 525, 6º andar cj 61 a 64, Vila Cordeiro, São Paulo -SP. CEP: 04581-060  
CALM (Central de Atendimento Leroy Merlin) Capitais  
4020-5376 Demais Regiões 0800-0205376



Points de collecte sur [www.quefairedemesdechets.fr](http://www.quefairedemesdechets.fr)  
Privilégiez la réparation ou le don de votre appareil !